

DESCRIPTION: MALE POWER/COMBO D CONFIGURATIONS

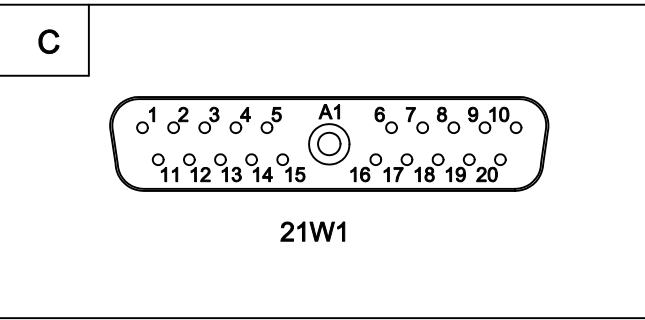
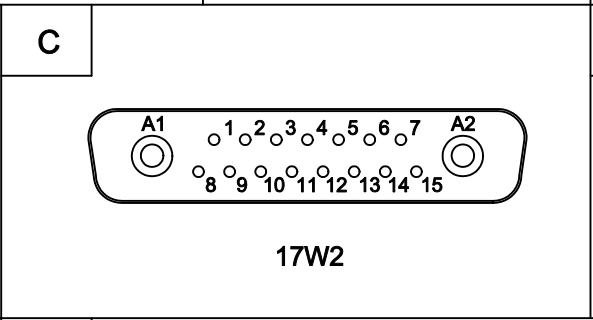
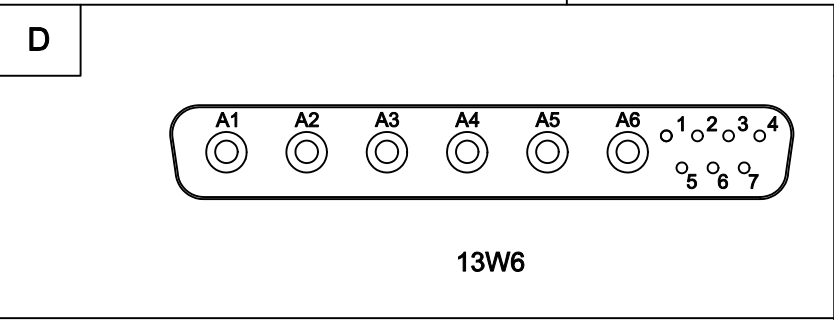
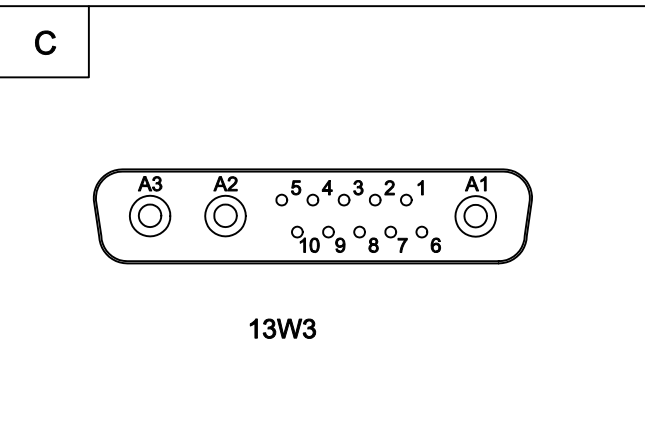
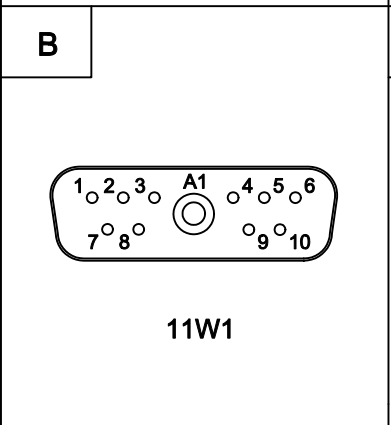
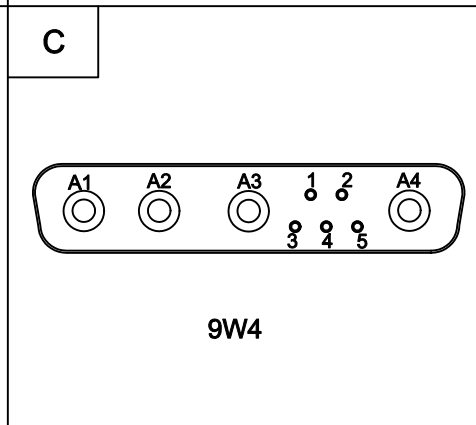
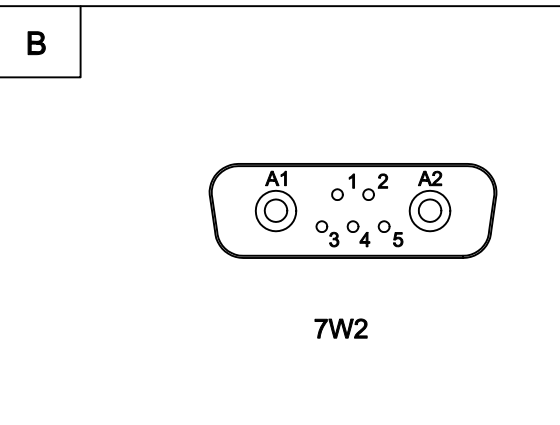
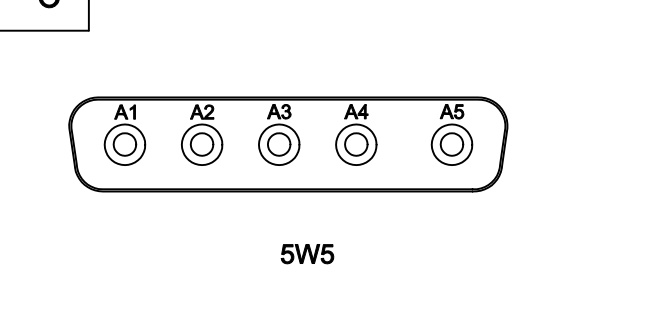
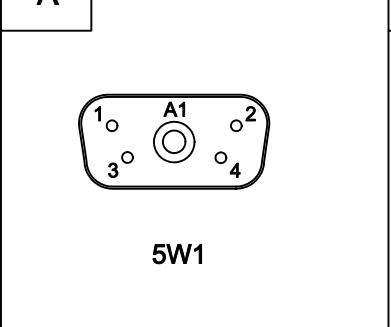
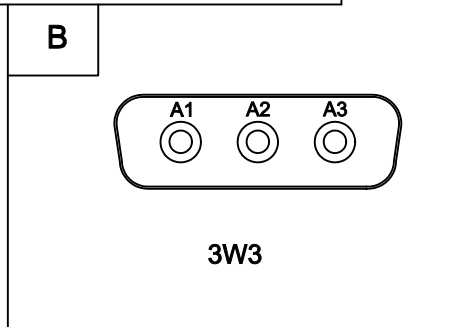
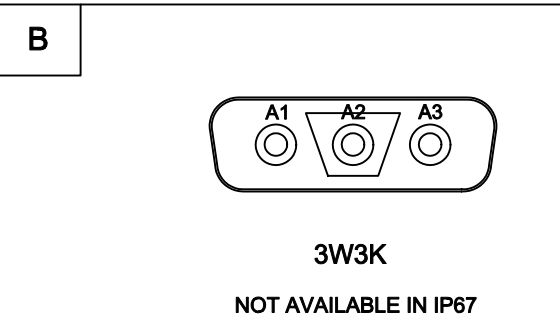

**SHELL SIZE CHART**

**A = 9 POSITION SHELL**  
**B = 15 POSITION SHELL**  
**C = 25 POSITION SHELL**  
**D = 37 POSITION SHELL**

**DO NOT SCALE FROM DRAWING**

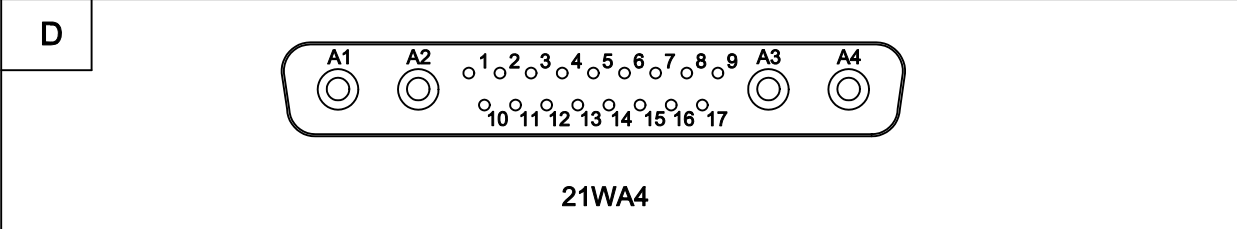

	THESE DRAWINGS AND SPECIFICATIONS ARE THE PROPERTY OF NorComp AND SHALL NOT BE REPRODUCED, COPIED OR USED AS THE BASIS FOR THE MANUFACTURE OF SALE OF APPARATUS WITHOUT WRITTEN PERMISSION.		DRAWN: <b>M. SIGMON</b>	DATE: <b>09-16-13</b>
			CHECKED:	DATE:
<h1>NorComp</h1>		SCALE: N.T.S.	SHEET 1	OF 1
		DWG NO. MALE POWER/COMBO D CONFIGURATIONS		