

DESCRIPTION: HIGH DENSITY - MACHINED CONTACTS - VERTICAL

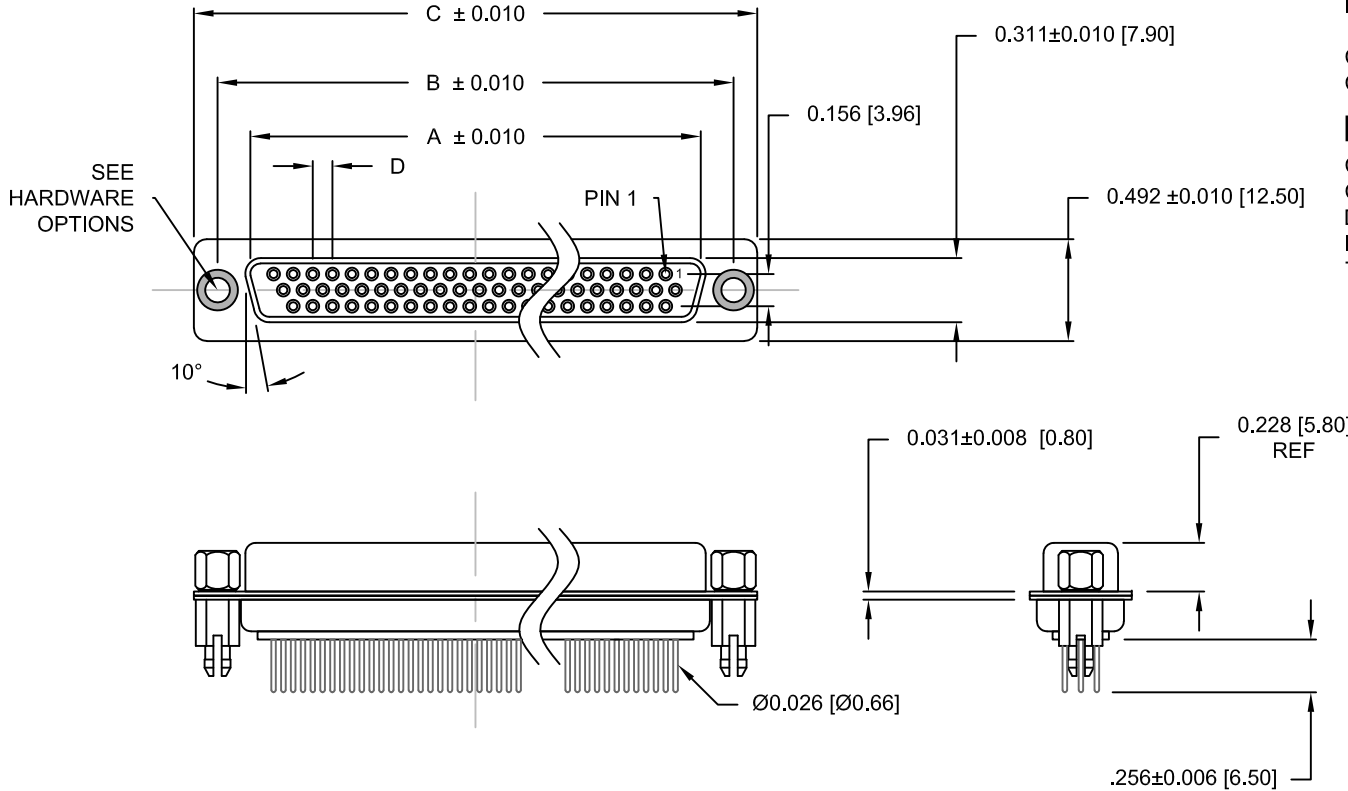

MATERIALS AND FINISH:

SHELL: STEEL MATERIAL, NICKEL FINISH
 INSULATOR: (SEE CHART) = 260°C, UL 94V-0 RATED, BLACK
 CONTACT MATERIAL: COPPER ALLOY
 CONTACT FINISH: SELECT GOLD PLATING

ELECTRICAL:

CONTACT CURRENT RATING: 5 AMPS
 CONTACT RESISTANCE: 10 mOHMS Max.
 DIELECTRIC WITHSTANDING VOLTAGE: 1,000VAC Min.
 INSULATION RESISTANCE: 5 GOHMS Min.
 TEMPERATURE RATING: -55° ~ +125° C

180-MYY-21YRYYY

SERIES _____
 MACHINED CONTACTS _____
 POSITIONS _____
 015 _____
 026 _____
 044 _____
 062 _____
 GENDER _____
 2 = FEMALE
 X = CONTACT LENGTH _____
 1 = 0.256"
 A = 0.140"
 SHELL PLATING _____
 3 = NICKEL
 RoHS COMPLIANT (260°C) _____
 HARDWARE OPTIONS _____
 00 = NO HARDWARE, Ø.120" HOLE
 01 = .098" CLINCH NUT (BOARD SIDE)
 02 = .250" CLINCH NUT (BOARD SIDE)
 03 = .250" CLINCH NUT (MATING SIDE)
 05 = .224" 4-40 BOARD LOCK
 08 = .228" BOARD LOCK, BOARD SIDE
 90 = .237" 4-40 BOARD LOCK
 FOR 0.093" BOARD MAX.
 91 = .224" 4-40 SPACER/BOARD LOCK
 92 = .237" 4-40 SPACER/BOARD LOCK
 FOR 0.093" BOARD MAX.
 PLATING OPTIONS _____
 1 = GOLD FLASH, ENTIRE CONTACT
 2 = 30u" GOLD, ENTIRE CONTACT
 3 = 50u" GOLD, ENTIRE CONTACT

DIMENSIONS (IN.)

No. OF PINS	A	B	C	D	Insulator Material
15	0.642	0.984	1.213	0.090	PA9T
26	0.969	1.311	1.543	0.090	PA9T
44	1.512	1.852	2.089	0.090	PA9T
62	2.157	2.500	2.732	0.095	PA6T

DIMENSIONS (mm)

No. OF PINS	A	B	C	D	Insulator Material
15	16.30	25.00	30.80	2.29	PA9T
26	24.60	33.30	39.20	2.29	PA9T
44	38.40	47.05	53.05	2.29	PA9T
62	54.80	63.50	69.40	2.41	PA6T

UNITS = INCHES [mm]

DO NOT SCALE FROM DRAWING



THESE DRAWINGS AND SPECIFICATIONS ARE THE PROPERTY OF NorComp AND SHALL NOT BE REPRODUCED, COPIED OR USED AS THE BASIS FOR THE MANUFACTURE OF SALE OF APPARATUS WITHOUT WRITTEN PERMISSION.

DRAWN: C. SMITH		DATE: 03-16-07	
SCALE: NTS	SHEET 1 OF 3	REV 23	
DWG NO. 180-MYY-21YRYYY			

RoHS COMPLIANT

NorComp

DESCRIPTION: CLINCH NUT HARDWARE

ALL CLINCH-NUTS ARE 4-40 INTERNAL THREADS

01X 0.098" (BOARD SIDE)

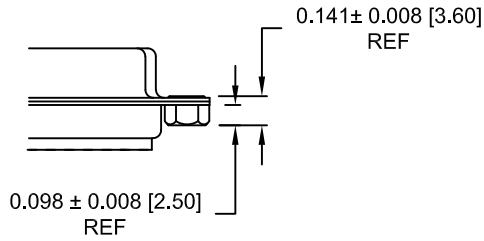

02X 0.250" (BOARD SIDE)

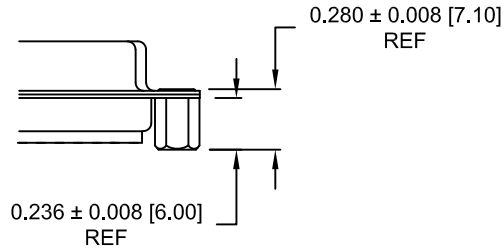

03X..... 0.250" (MATING SIDE)

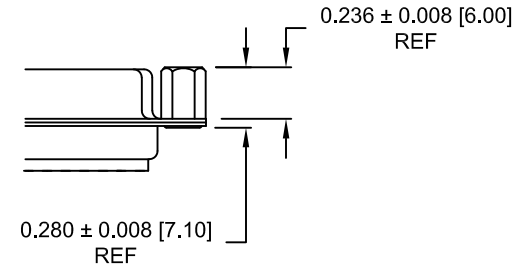

05X 0.224" BOARD SIDE

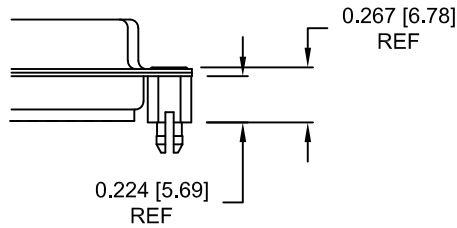

08X 0.228" BOARD SIDE

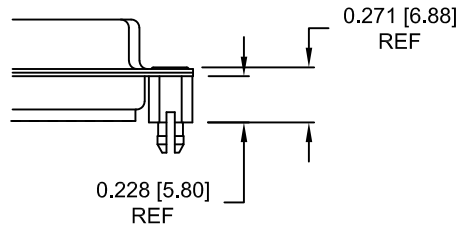

91X 0.224" BOARD SIDE
0.189 MATING SIDE

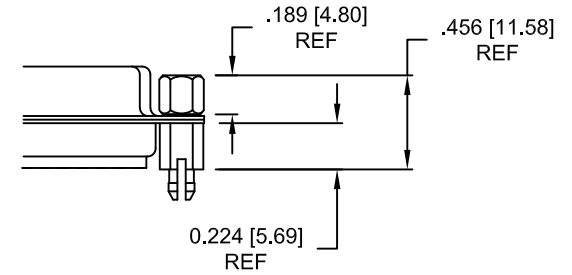

90X 0.237" BOARD SIDE

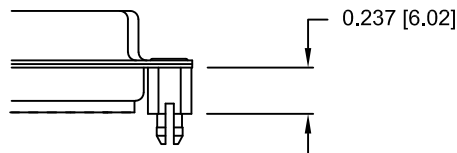

92X 0.237" BOARD SIDE
0.189 MATING SIDE

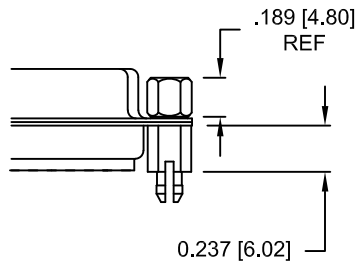

NOTE: 4-40 FEMALE SCREW LOCK IS REMOVABLE

UNITS = INCHES [mm]

DO NOT SCALE FROM DRAWING

NOTE: 90 & 92 OPTION FOR 0.093" MAX. BOARD THICKNESS



THESE DRAWINGS AND SPECIFICATIONS ARE THE PROPERTY OF NorComp AND SHALL NOT BE REPRODUCED, COPIED OR USED AS THE BASIS FOR THE MANUFACTURE OF SALE OF APPARATUS WITHOUT WRITTEN PERMISSION.

DRAWN: C. SMITH		DATE: 03-16-07	
SCALE: NTS	SHEET 2	OF 3	REV 23
DWG NO. 180-MYY-21YRYYY			

RoHS COMPLIANT

NorComp

DESCRIPTION: HIGH DENSITY - MACHINED CONTACTS - VERTICAL

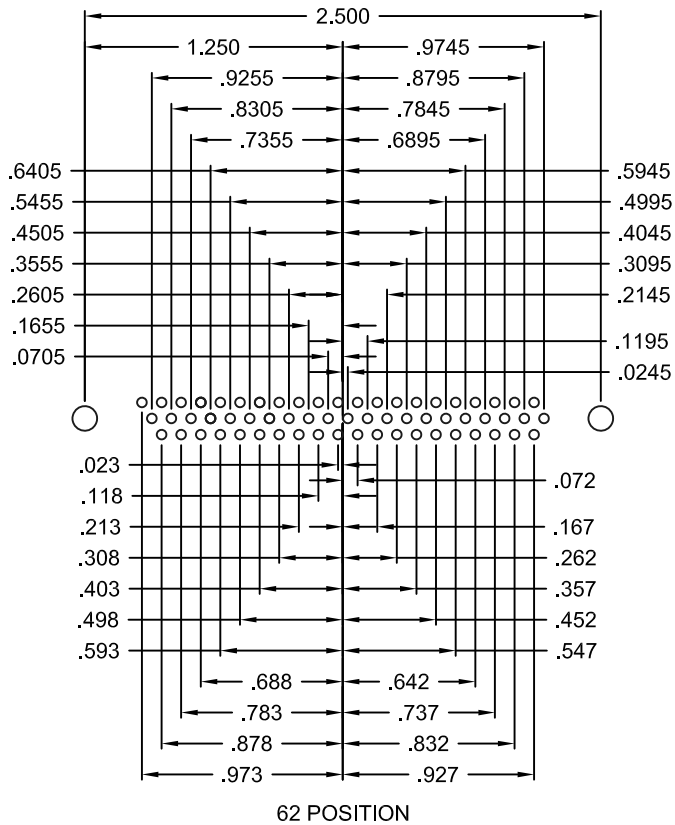
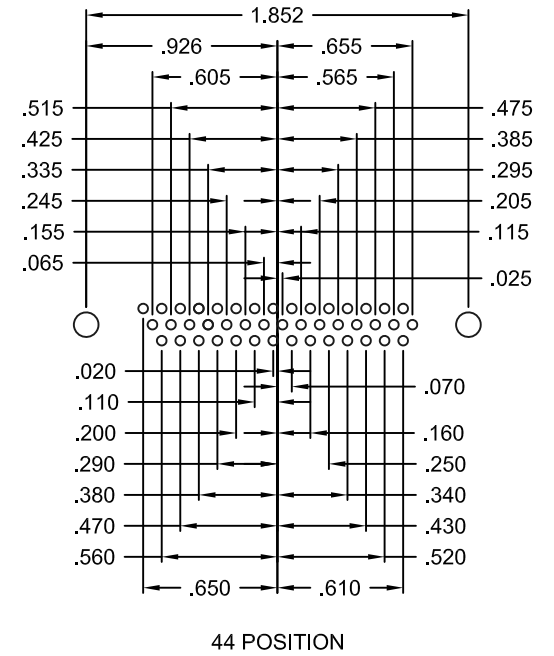
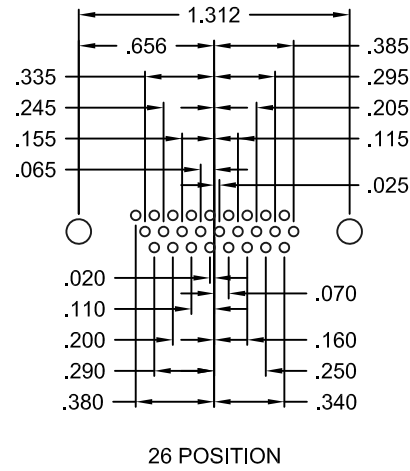
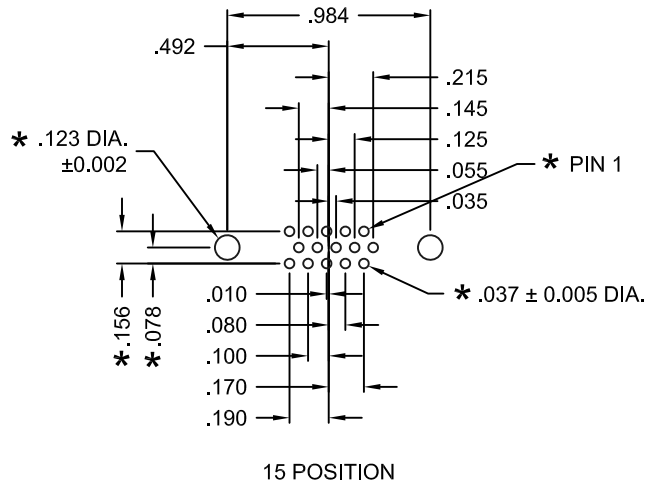

180 SERIES
HIGH DENSITY
VERTICAL

HOLE PATTERN SHOWN
ARE FOR FEMALE

* TYP. ON ALL SIZES

UNITS = INCHES [mm]

DO NOT SCALE FROM DRAWING

	THESE DRAWINGS AND SPECIFICATIONS ARE THE PROPERTY OF NorComp AND SHALL NOT BE REPRODUCED, COPIED OR USED AS THE BASIS FOR THE MANUFACTURE OF SALE OF APPARATUS WITHOUT WRITTEN PERMISSION.		DRAWN: C. SMITH	DATE: 03-16-07
	NorComp		SCALE: NTS	SHEET 3 OF 3
DWG NO. 180-MYY-21YRYYY				