

TORQUE SETTING

6.1-9.5 in-lbs [7-11 kgf-cm]

MATERIAL & FINISH

BACKSHELL: ABS - UL HB RATED - BLACK
 BUSHING & BAFFLE: SILICONE
 THUMBSCREWS: NICKEL PLATED BRASS
 OPERATION TEMPERATURE: 0°C TO 80°C (BASED ON ABS)
 CABLE DIAMETER: 0.350 in [8.89mm] MAX
 0.130 in [3.30mm] MIN

MATING PARAMETERS:

RECOMMENDED MAX TORQUE: 40 in-oz
 NOMINAL GASKET COMPRESSION: 0.055"

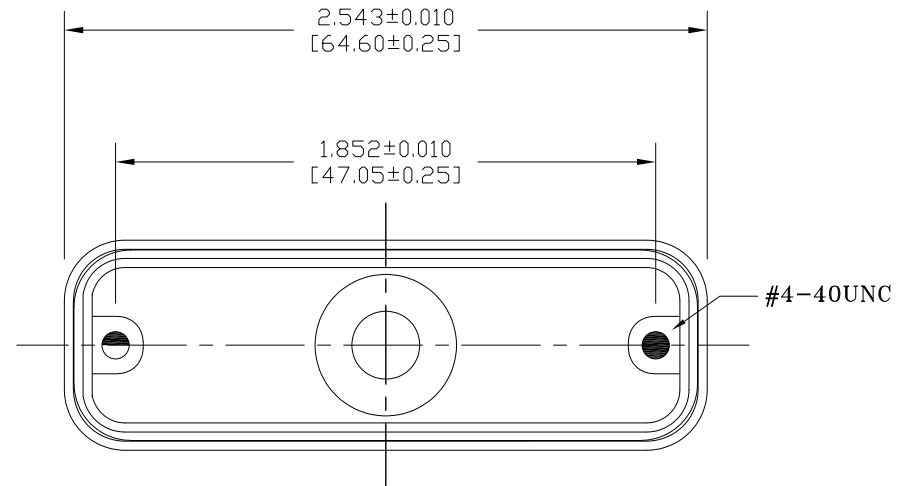

RoHS COMPLIANT



THESE DRAWINGS AND SPECIFICATIONS ARE THE PROPERTY OF NorComp AND SHALL NOT BE REPRODUCED, COPIED OR USED AS THE BASIS FOR THE MANUFACTURE OR SALE OF APPARATUS WITHOUT WRITTEN PERMISSION.

DRAWN: M. SIGMON

DATE: 12/15/2010

UNITS = inch [mm]

DO NOT SCALE FROM DRAWING

NorComp

SCALE: NTS

SHEET 1 OF 1

REV 8

DWG NO.

967-025-010R011