

SPECIFICATIONS:

MATERIALS:	
BACKSHELL:	DIE-CAST ZINC ALLOY
BACKSHELL PLATING:	NICKEL OVER COPPER
JACKSCREWS:	ZINC PLATED STEEL
HOUSING SCREWS:	ZINC PLATED STEEL
STRAIN RELIEF SCREWS:	ZINC PLATED STEEL
COVER PLATE:	ZINC PLATED STEEL
STRAIN RELIEF CLAMP:	ZINC PLATED STEEL

BACKSHELL KIT INCLUDES:

- (2) BACKSHELL HALVES
- (2) 4-40 JACKSCREWS
- (1) HOUSING SCREWS
- (3) STRAIN RELIEF SCREWS
- (1) STRAIN RELIEF CLAMP
- (1) COVER PLATE

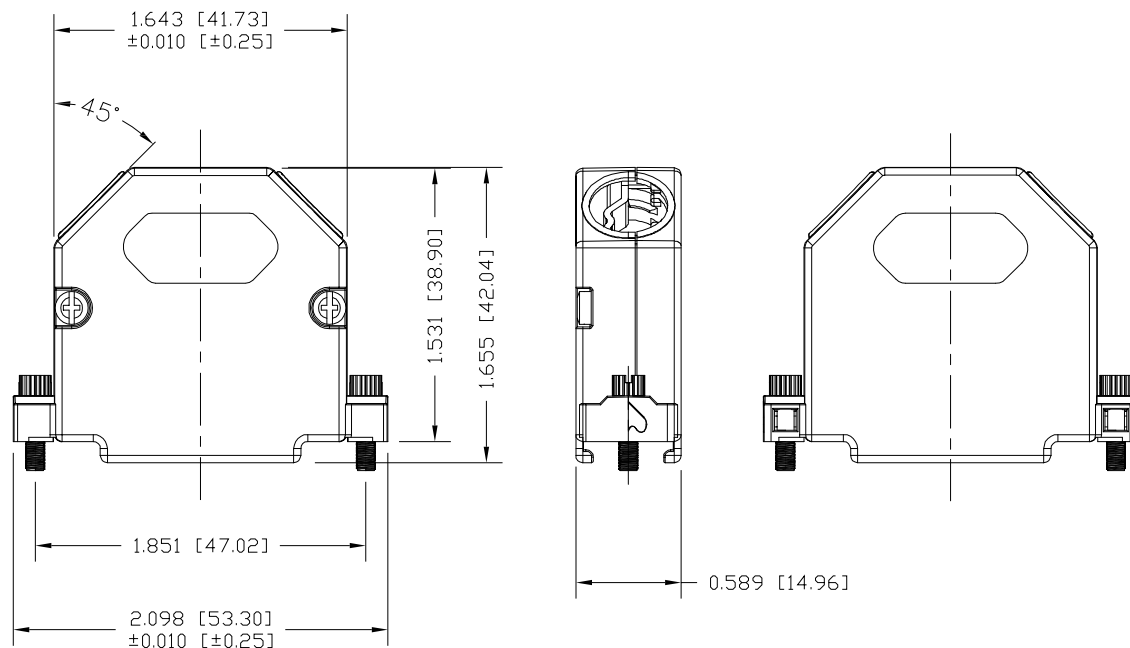

RECOMMENDED CABLE DIAMETER: 0.189 [4.80] - 0.433 [11.00]

RoHS COMPLIANT

UNITS = inch [mm]

DO NOT SCALE FROM DRAWING



THESE DRAWINGS AND SPECIFICATIONS ARE THE PROPERTY OF NorComp AND SHALL NOT BE REPRODUCED, COPIED OR USED AS THE BASIS FOR THE MANUFACTURE OR SALE OF APPARATUS WITHOUT WRITTEN PERMISSION.

DRAWN:
M. SIGMON

DATE:
05/12/2015

GENERAL TOLERANCE
ANGLE (±5°)
LINEAR = ±0.015 [±0.38]

NorComp

SCALE:
NTS

SHEET 1 OF 1

REV 1

DWG NO.

959-025-030R121