

DESCRIPTION: SHIELDED DUST CAPS - MALE

MATERIAL: ABS WITH 50 MICRON GRAPHITE COATING

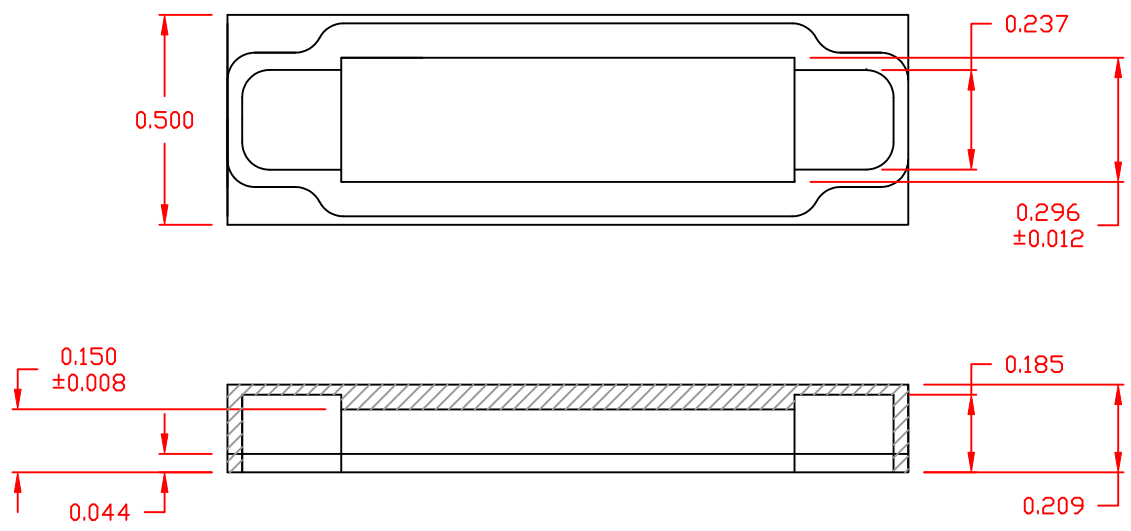

1 YY IN PART NUMBER
 POSITION (09, 15, 25)
 GENDER: 1 = MALE (BLUE)

ATTENUATION EFFICIENCY:

FREQUENCY MHZ	ATTENUATION dB	FREQUENCY MHZ	ATTENUATION dB	FREQUENCY MHZ	ATTENUATION dB	FREQUENCY MHZ	ATTENUATION dB
0.1	125	4	100	150	90	700	68
0.2	127	6	90	200	100	800	56
0.4	122	15	90	250	82	900	58
0.6	123	40	87	300	71	1000	52
1	120	60	82	400	70		
2	118	100	87	600	67		

RoHS COMPLIANT

	THESE DRAWINGS AND SPECIFICATIONS ARE THE PROPERTY OF NorComp AND SHALL NOT BE REPRODUCED, COPIED OR USED AS THE BASIS FOR THE MANUFACTURE OR SALE OF APPARATUS WITHOUT WRITTEN PERMISSION.		DRAWN: PAM JENKINS	DATE: 10-9-00
			CHECKED:	DATE:
NorComp		SCALE: 2:1	SHEET 1 OF 1	REV 0
		DWG NO. 160-020-1YYR000		